



**ACP
(CONCRETE)
LIMITED**

**Low Cost
All Weather Flooring**

**Limited Groundwork's
Minimum Infill Required**

**Ease and Speed
of Installation**

**Immediate Floor and
Working Area**

**Fast-Track Construction
means
The Lowest Cost Flooring**

**Full Layout and
Design Service Available**

**Rapid Response and
Quick Delivery**

PRESTRESSED CONCRETE FLOOR BEAMS

225mm deep

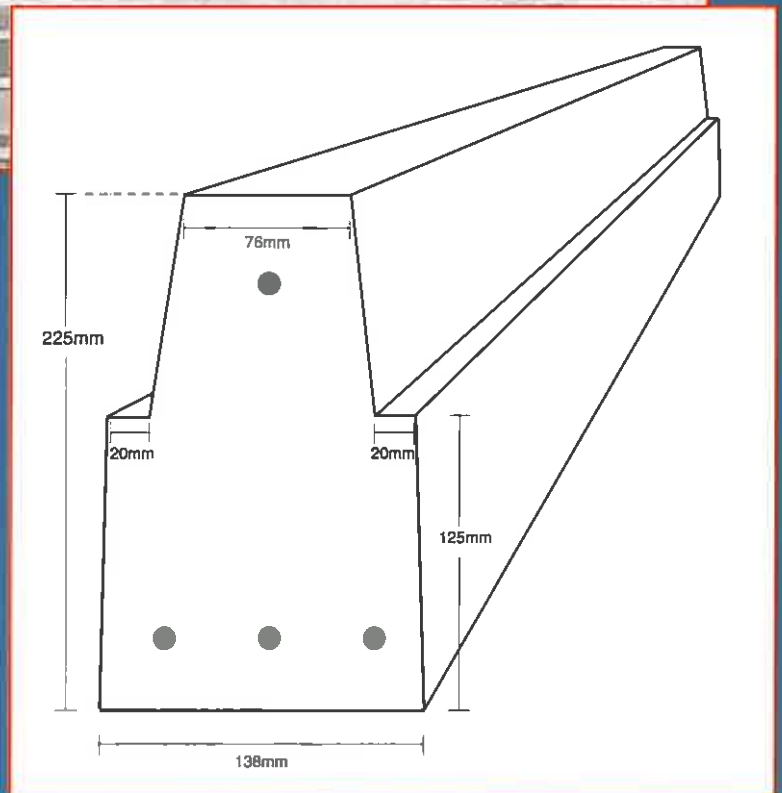
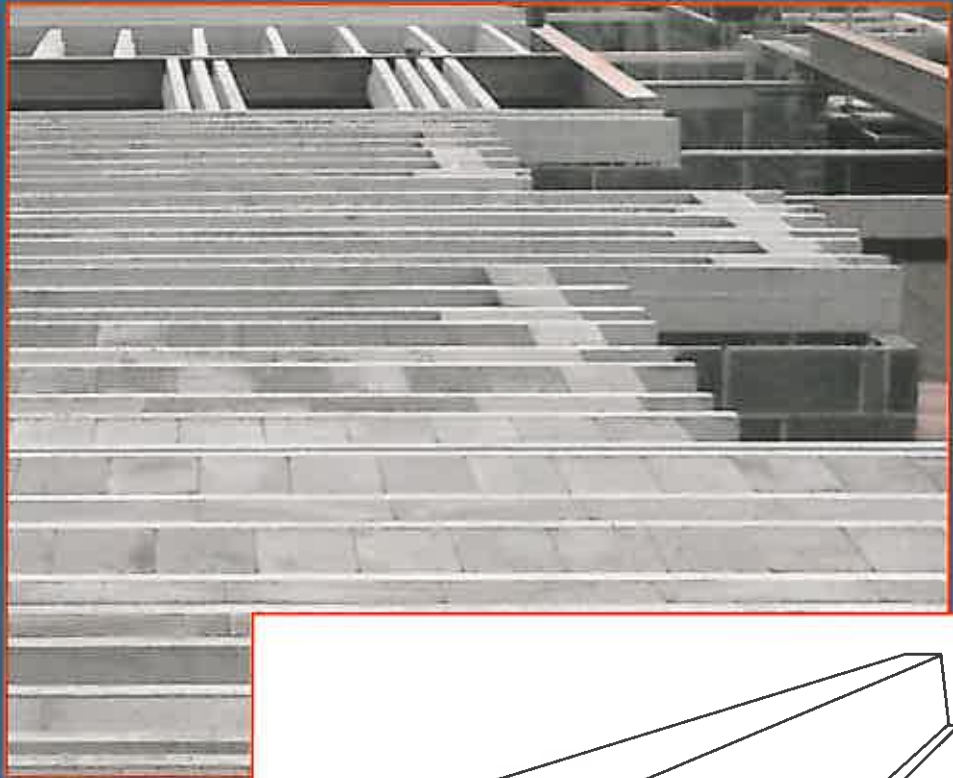

**Suitable for use
at both ground and upper floor levels in:
Private Housing • Hotels
Commercial Developments
Nursing Homes • Residential Developments**

PRESTRESSED CONCRETE FLOOR BEAMS

Shoehangers

Purpose designed shoehangers, allowing the suspension of floor beam between floor beams in the floor design, where no supporting walls are available to span onto. (Floor design approval from manufacturer required).

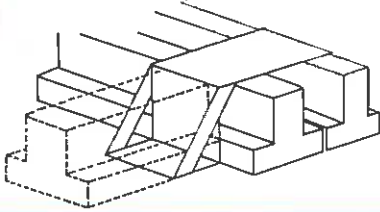

Parallel Edge Detail Slip Block

Available in 370mm lengths x 96mm wide x 110mm deep for use within the floor construction. Doing away with the need to split bricks or blocks on site.

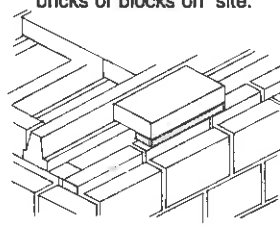

End Edge Detail Slip Blocks

These purpose made slip blocks are available for use within the floor construction at both 530 and 305mm Floor Beam centres.

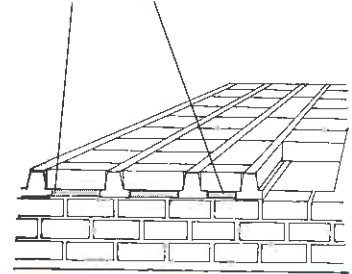

Ceiling Clips:

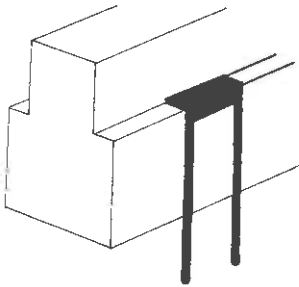

Ceiling Clips:

These are readily available and are easily installed within the floor construction, easing and simplifying the installation of a suspended ceiling.

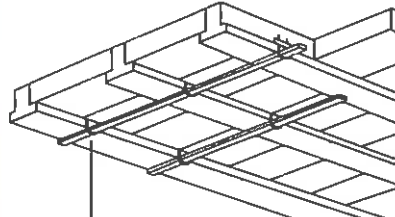

Clip spacing at 400mm or 600mm Centres

Telescopic Air Vents

The underfloor void ventilation pack is installed during bricklaying, below the d.p.c. at 2000mm centres. This will ensure adequate ventilation to suspended ACP concrete ground floors. (1985 B. Regs . C4)

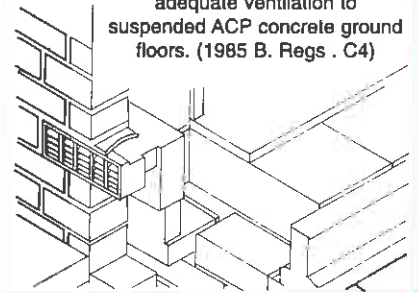

1. SCREEDED FLOOR
- Grouted then 65mm Sand/Cement screed
2. LIGHTWEIGHT FLOOR
- Grouted then 50mm Insulation + 18mm Chipboard

FLOOR DENSITIES (Grouted only)

530 Centres 305 Centres

Dense Block (1960 Kg/m³)

278 Kg/m² 338 Kg/m²

Lightweight Block (1350 Kg/m³)

226 Kg/m² 294 Kg/m²

Armstrong Airtec (750 Kg/m³)

710 Centres 520 Centres

155 Kg/m² 180 Kg/m²

CLEAR SPAN (100mm minimum bearing each end required)

Block Density	Armstrong Airtec Floor Block 750 Kg/m ³		100mm Lightweight Concrete 1350 Kg/m ³		100mm Dense Concrete 1960 Kg/m ³		
	710	520	530	305	530	305	
Joist Centres (mm)							
Imposed Load 1.5 kN/m ²	1. Screeded Floor	6.369	7.175	6.332	7.886	6.046	7.614
	2. Lightweight Floor	7.411	8.242	7.049	8.662	6.663	8.307
2.0 kN/m ²	1. Screeded Floor	5.986	6.774	6.044	7.567	5.793	7.326
	2. Lightweight Floor	6.829	7.652	6.660	8.245	6.331	7.937
2.5 kN/m ²	1. Screeded Floor	5.663	6.432	5.792	7.283	5.570	7.067
	2. Lightweight Floor	6.364	7.171	6.329	7.883	6.043	7.611
3.5 kN/m ²	1. Screeded Floor	5.148	5.878	5.369	6.799	5.190	6.621
	1. Screeded Floor	4.582	5.260	4.876	6.223	4.740	6.086

The table above is for reference only. A more specific Safe Load calculation based on the salient loading details, can be produced by contacting our Technical department at the address or telephone number shown below.

A FULL TECHNICAL SERVICE IS PROVIDED INCLUDING DESIGN LAYOUT DRAWINGS, AND SUPPORT CALCULATIONS FOR SUBMISSION TO YOUR LOCAL BUILDING CONTROL DEPARTMENT



ACP (CONCRETE) LIMITED

Risehow Industrial Estate, Flimby, Maryport, Cumbria CA15 8PD

Tel: 01900 814659 Fax: 01900 816200

Website: acpconcrete.co.uk

E-mail: acp.sales@thomasarmstrong.co.uk

Members of the British Precast Concrete Federation and Precast Flooring Federation